

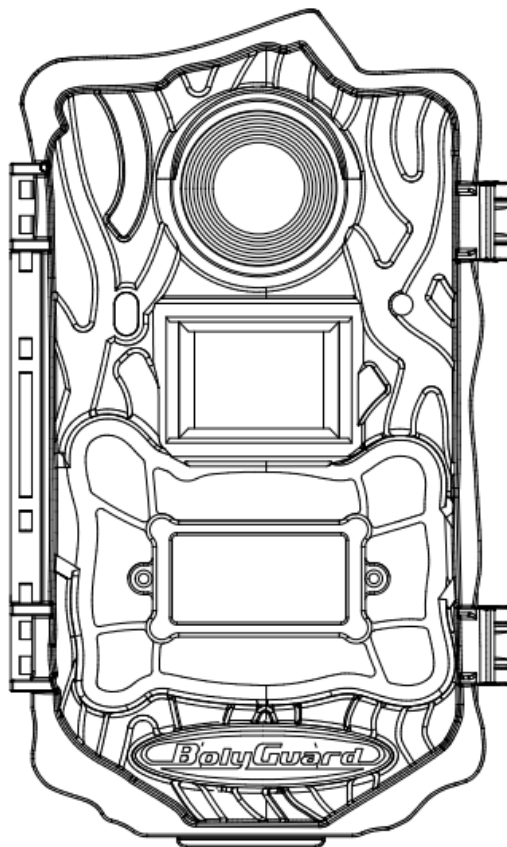

Hunting Camera

BG962-X30W/ BG962-K30W



Contents

1.Basic	1
1.1General Discription.....	1
1.2 Camera at a Glance	2
1.3 Shooting Information Display	4
1.4 Cautions	4
2.Quick Start Guide.....	6
2.1Power Supply	6
2.2 Insert The SD Card.....	6
2.3 Do The Camera Common Operation	7
3.Advanced Operation.....	8
3.1 Work Mode	8
3.2Trigger Mode	8
3.3 Item Settings	9
3.4Default Setting.....	13
3.5 Power Off.....	13
4.Mounting The Camera	14
PIR Detection Zone	15
Technical Specifications.....	16
Parts List	17

1.Basic

1.1 General Discription

Thanks for your purchase of Boly Scouting camera. This camera is a surveillance device working automatically. It can be triggered by any movement of human or animal in a certain region of interested monitored by a highly sensitive Passive Infra-Red (PIR) motion sensor, and then take high quality pictures (up to 30 mega pixels) or video clips. It can take clear, black and white pictures or videos in the dark night.

BG962-X30W:This camera integrates 40 940nm LEDs and xenon flash. The xenon flash as supplement light at night turns to infrared light after filter as a result of which it can reduce time of exposure. This own function leads to no motion blur in the video clips.

BG962-K30W: This is a digital infrared surveillance camera with 40 940nm LEDs.

There is a 2” color LCD display screen on the camera. The device is designed for outdoor use and resistant against water and snow. Furthermore, the camera can be used as a portable digital camera. Pictures or videos can be taken manually by pressing  on the operation panel.

1.2 Camera at a Glance

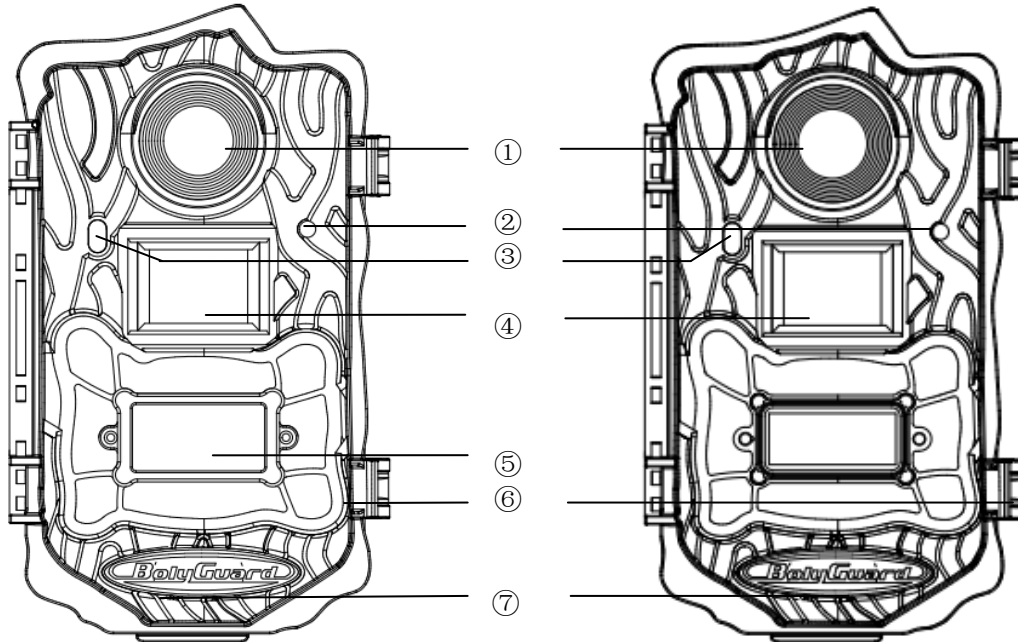

Fig. 1: Front view of BG962-X30W

Fig. 2: Front view of BG962-K30W

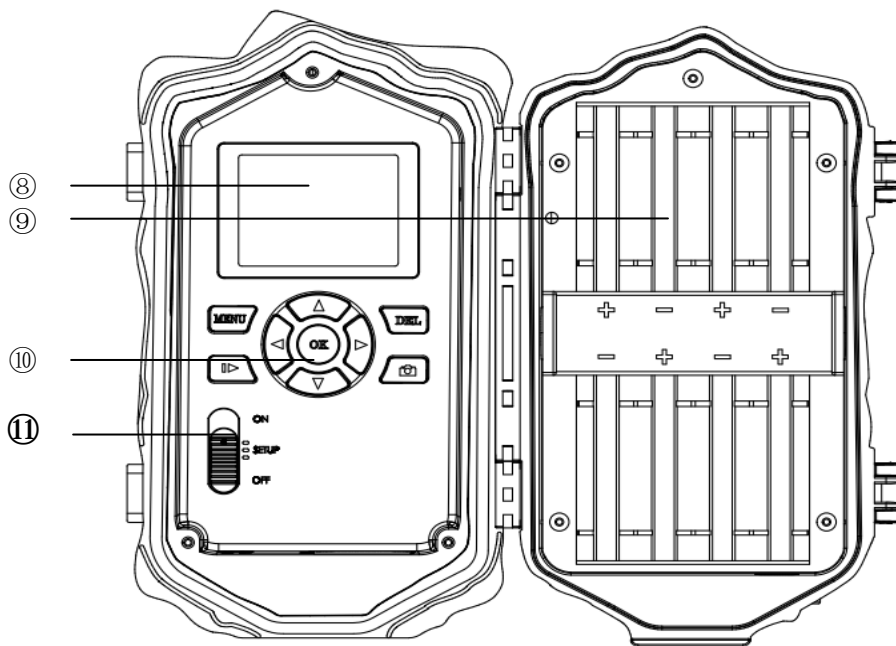

Fig. 3: Inner panel view

1.Basic

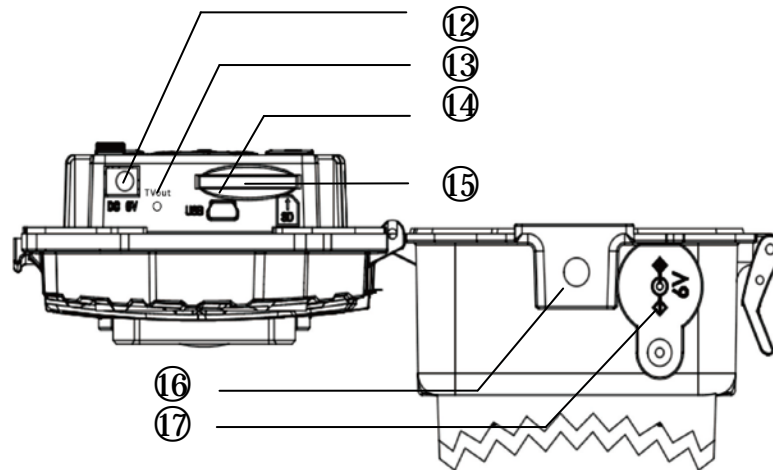







Fig. 4: Bottom view

①	Lens	②	Mic	③	Indication LED
④	PIR	⑤	Flash	⑥	Lock
⑦	Speaker	⑧	LCD display	⑨	Battery bays
⑩	Operation panle	⑪	Power Switch	⑫	DC 6V
⑬	TV out	⑭	USB port	⑮	SD card slot
⑯	Bottom Screw	⑰	DC hole and stoper		

MENU	Enter/Exit the menu	DEL	Delete photos or videos
	Exchange between preview and playback state		Select option(left ,right) Change the photo size
	Select Item(UP), Increase vaule		Select Item(DOWN), Decrease vaule
OK	Make selection (OK)		Capture photos or videos



OFF:turn off the power.

SET UP:change camera settings.

ON:enter into hunting mode or security mode

1.3 Shooting Information Display

When the camera is turned on (power switch is slid to SETUP position), the current settings will be displayed on the screen.

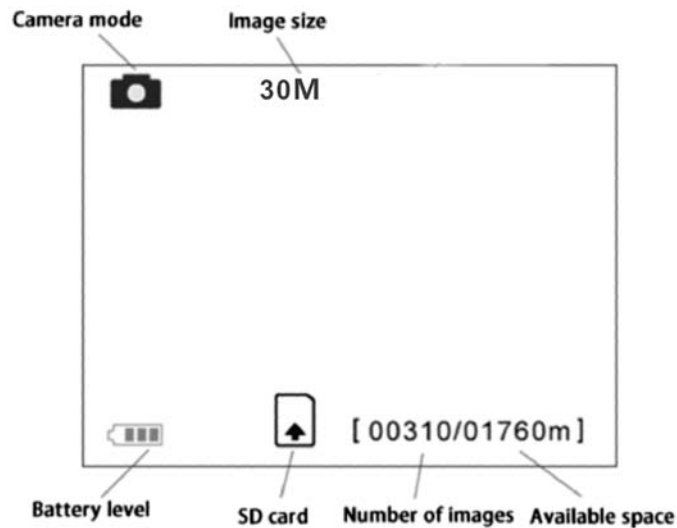

Fig. 5: LCD Display

1.4 Cautions

- ★The camera is supplied by 8 AA batteries or DC power adapter with output of 6V (recommended) though the range of voltage can be 5V to 12V. Please install batteries according to shown polarity.
- ★Please insert the SD card when the power switch is in OFF position before testing the camera. The camera has no internal memory for saving images or videos. If no SD card is inserted, the camera will shut down automatically after an indication

beep.

- ★Please do not insert or take out the SD card when the power switch is in the ON position.
- ★It is recommended to format the SD card by the camera when used for the first time.
- ★The camera will be in USB mode when connected to a USB port of a computer. In this case, the SD card functions as a removable disk.
- ★In SETUP mode, the camera will shut down automatically after 3 minutes if no operation is done. Please turn on the power again if you want to continue to work with the camera.

2.Quick Start Guide

What You Need

To use camera ,you need:

- An unlocked SD card;
- 4 or 8 AA batteries,High-density and high-performance alkaline batteries are recommended
- A PC with a USB 2.0 port and the Internet access;

2.1Power Supply

1)Battery Power:Load 4 or 8 AA batteries according to shown polarity.

2)External Power:Insert 6V DC external power adapter.

When in a low-battery state,the camera will be automatically shut down after indication sounds. Please change the batteries in this case.



NOTE:

- The battery can be just a backup for emergency when using external power or solar charging.
- There will be risk of explosion if battery is replaced by an incorrect type.
- Please deal with waste battery according to the local rule.

2.2 Insert The SD Card

Insert a new SD card into the card slot. Please note that the SD card is on the “write” (not locked) position otherwise the camera will not function correctly.

2.3 Do The Camera Common Operation

To	Do This
Preview state	Flip the power switch on SETUP into Homescreen.
Setting state	Flip the power switch on SETUP,Press MENU into Setting state.
Playback state	Flip the power switch on SETUP,Press  into playback state.
Switch photo and video mode	When in Homescreen,Press▲▼to change between the photo,video and Pic+video mode.
Manual capture a photo	When in Homescreen(photo mode),Press  to capture a photo.
View photos and videos	When in playback state,Press▲▼ to view photos and videos.
Delete photos or videos	When in playback settingmode,Press ▲▼ to select DELETE Item,Press DEL to delete a photo or all.

*The key press is based on the button of remote control device.

1.Preview state: Display the view finder and status of camera .

2.Setting state:Do customer settings.

3.Playback state:View photos or videos via display.

3.Advanced Operation

3.1 Work Mode

SETUP mode: Switch the camera to SETUP position to set camera ,manual capture ,playback the photos and video clips or send MMS manually.

Hunting mode: Switch the camera to ON position to hunt or monitor animals. When the animal or human intrudes into the monitoring region, the camera will take pictures or videos automatically according to the previous programmed settings. After switching the camera to ON position, the motion indication LED (red) will blink for about 10 seconds. This time interval is for you to position the camera for automatic surveillance operation, e.g. to close the camera and lock it, to fix the camera on a tree and walk away.

Off mode: Switch the camera to OFF position to power off the camera.

3.2 Trigger Mode

PIR Triggering: PIR triggering is the default setting. The camera works only when motions get detected, while, if PIR sensitivity is set as PIR OFF, the camera stops PIR triggering.

Timer Triggering: The Timer Triggering is OFF which means the timer triggering is disabled. While changing the timer triggering interval to a non-zero value, the camera starts to work at a preset interval.

PIR&Timer Triggering:For both PIR triggering and Timer triggering, the user need go to PIR sensitivity to set “normal, high or low” sensitivities according to the external environments, and set the Timer interval to a desired non-zero value. The camera will capture pictures or videos in a preset time interval even there is no motions detected, the camera will also capture pictures and videos if motions get detected.

3.3 Item Settings

Flip the power switch on SETUP,Press MENU into SETUP Mode. You can set menu according to the actual needs.The following table shows the camera setting items.

Camera Setting Items

Setting Items	Description
Camera Mode	Choose capturing photos, recording videos or photo with a video clip.
Photo Size	Choose the photo size, e.g. 30MP, 20MP or 14MP.
Video Size	Choose the video size :1920x1080, 1280x720 or 640x480.
Photo Burst	Choose the continuous shooting numbers after each triggering.
Video Length	Choose duration of recording video. This parameter is effective and can be adjusted only when the device in the video mode under ON mode. Its value extends from 10 to 180 seconds. The default value is 10 seconds. Press LEFT

3.Advanced Operation

	and RIGHT to decrease or increase the value by 10 seconds.
Set Clock	Set camera date and time. You can change the date and time of the device by setting this parameter when necessary, e.g., after every battery change. The date format is year/month/day , the time format is hour: minute: second . The valid value for year is between 2016 and 2050.
Time Lapse	Time lapse means the camera can capture images or videos at a preset time interval regardless of whether motions are detected. The default parameter is Off, which means the timer function is disabled. Changing this parameter to a non-zero value turns on the Time Lapse mode, and camera will take photos at given time interval. Please note that if PIR Trigger is set to Off, then Time Lapse can't be set to Off.
PIR Trigger	Choose sensitivity of the PIR sensor. This parameter defines the sensitivity of the PIR: High, Normal, Low and Off. The default value is "Normal". The higher sensitivity indicates that the camera is more easily to be triggered by motion, taking more pictures or recording more videos. It is recommended to use high sensitivity in room or environment with little interference, and to use lower sensitivity for outdoor or environment

3.Advanced Operation

	<p>with lots of interference like hot wind, smoke, near window etc. Furthermore, the sensitivity of the PIR is strongly related to the temperature. Higher temperature leads to lower sensitivity.</p> <p>Please note that if Time Lapse is set to Off, then PIR Trigger can't be set to Off.</p>
PIR Interval	<p>This parameter indicates how long the PIR (Passive Infrared motion sensor) will be disabled after each triggering in ON mode. During this time the PIR of the device will not react to the motion of human (or animals). The minimum interval is 0 second, it means the PIR works all the time. The maximum interval is 1 hour. It means the PIR will be disabled for 1 hour after each triggering. Press LEFT or RIGHT to decrease or increase the value.</p>
Work Hour	<p>This parameter defines a certain time in a day when the camera can be triggered, while in the rest of the time the device is shut off. The effective value ranges from 00:00 to 23:59.</p> <p>The default set is Off which means the camera works all along. Timer switch On means the camera works only during the time according to the preset settings.</p>
Game Call	<p>It means this camera can play audio file at a preset time clock of a day. The audio file must be saved in the directory of</p>

3.Advanced Operation

	\DCIM\100BMCIM\ with a name of AUDIxxxx(from 0000 to 9999).WAV after format the SD card and setting the game call as on mode. It is better that the length of the audio file less than 2 minutes, otherwise it will consume much more power.
Language	Choose the menu language you need.
Beep Sound	Enable or disable the beep sound.
Camera Posit	It means camera position. You can set A-Z position for your camera, so that you can distinguish which photo is taken by which camera.
Recycle Storage	In hunting mode, when the SD card is full, the first images or videos will be covered by new getting pictures or videos. So that you don't need to retrieve your memory card manually. But in SETUP mode, SD can't recycle storage.
Format SD	All images and videos in the SD card will be deleted, so make sure that you have made a backup of important data.
Default Set	Restore all customer settings to default values.
Version	Version information.

***After changing each setting in SETUP mode you must press "OK", otherwise the camera will stay at the default setting .**

3.4Default Setting

Setting Items	Default	Options
Camera Mode	Photo	Video ,Pic+Video
Photo Size	30M	20M/14M
Video Size	1920x1080	1280x720/640x480
Photo Burst	1 Photo	1-5 photos
Video Length	10 Sec	10–180 sec
Set Clock	Enter	
Time Lapse	Off	5-55Min / 1-8H
PIR Trigger	Normal	High /Low
PIR Interval	5Sec	0–55 Sec / 1–60 Min
Work Hour	Off	On
Game Call	Off	On
Language	English	Deutsch / Suomi Svenska / Norsk Dansk /Italiano/Russian
Beep Sound	On	Off
Camera Posit	Off	A-Z Position
Recycle Storage	Off	On
Format SD	Enter	
Default Set	Save	
Version	Enter	

3.5 Power Off

Switch the camera to OFF position to power off the camera. Please note that even in OFF mode, the camera still consumes certain power at μA level. Therefore, please remove the battery if the camera will not be used for a long time.

4. Mounting The Camera

When use the camera in outdoor environment, such as hunting or monitoring the living habits of wild animals, you need to mount the device on a certain place properly. It is recommended to mount the camera on a tree, to get the optimal picture quality, the recommended distance is 16ft from the tree to the target monitoring area and recommended height from the ground is 4.9ft~6.5ft. Adjust the viewing angel properly (view angle of this camera is 110°).

There are three ways to mount the camera: using a band shaped belt, python lock or mounting bracket.

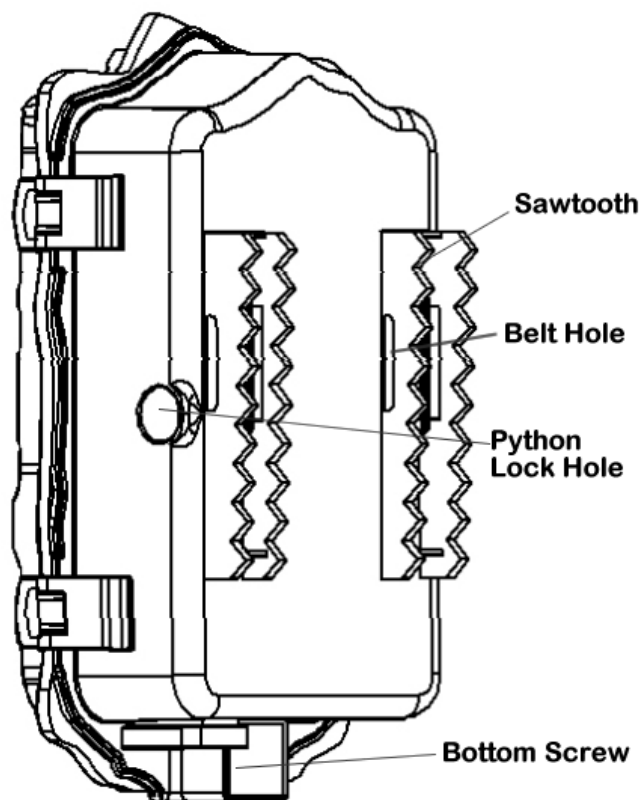

Fig. 6: The back panel of the camera

PIR Detection Zone

This camera has a new design of PIR and the new PIR is patented. The new patented PIR's detection range can reach to 100ft in good environments. Following picture shows the compared detection zone between normal PIR and the new patented PIR.

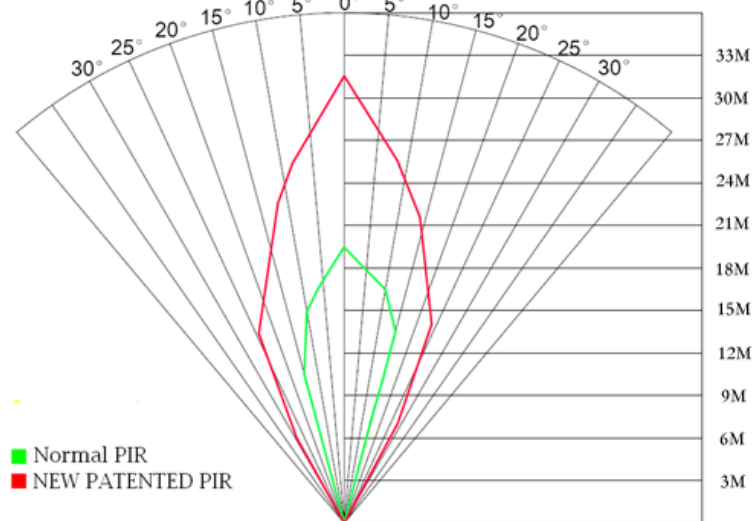

Fig. 7: PIR Detection Zone

The PIR detection angle (α) is just smaller than the field of view (FOV) angle (β). The advantage of this design is to reduce empty picture rate and capture most, if not all, motions.

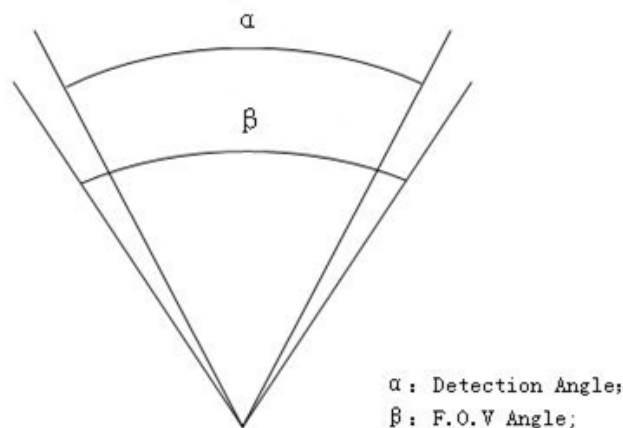

Fig.8: Detection angle vs. FOV angle

Technical Specifications

Image Sensor	14MP Color CMOS,
Lens	F/NO=2.4 FOV(Field of View)=110°
PIR detection range	100ft
Display Screen	2.0" LCD
Memory Card	From 8 MB to 64GB
Picture Resolution	30MP/20MP /14MP
Video Resolution	1920x1080 1280x720 640x480
PIR Sensitivity	Adjustable (High/Normal/Low)
Trigger Time	<1s
Weight	0.35 kg(without battery)
Operation/Storage Tem.	-20 - +60°C
Photo Burst	1-5
Video Length	10-180s
Power Supply	8×AA or 4×AA External DC 6V,2A
Stand-by Current	<300uA
Low Battery Alert	LED Indicator
Sound Recording	Available
Mounting	Rope/Belt/Python lock
Dimensions	160 x 90 x 75 mm
Operation Humidity	5% - 90%
Security Authentication	FCC, CE, RoHS

Parts List

Part Name	Quantity
Digital Camera	One
USB Cable	One
Belt	One
Mounting Bracket	One
User Manual	One
Warranty Card	One

For more detail about our product or software, please download from our website: <http://www.bolyguard.com/download.html>.



Version 1.0